

Single Acting Hydraulic Actuators

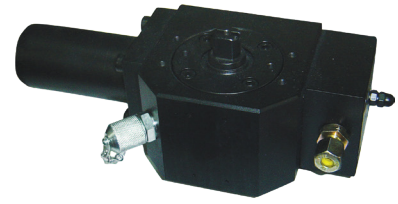

Optional Accessories

- Hydro-Lock
- Special Coating for Submerged Actuators
- Manual Hand Pump
- Ballast / Cargo System Control Units
- Linear Type for Globe / Gate Valves

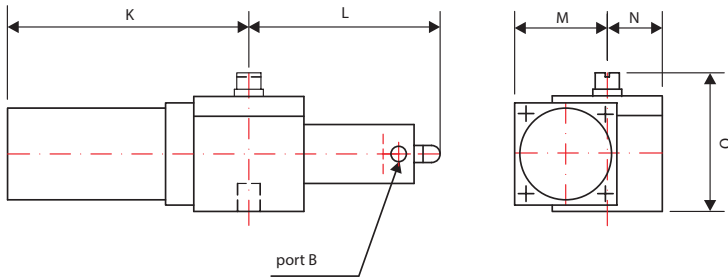
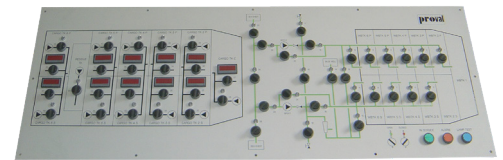
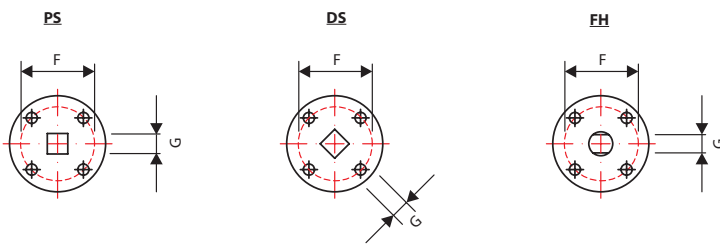

Mimic Control Panel

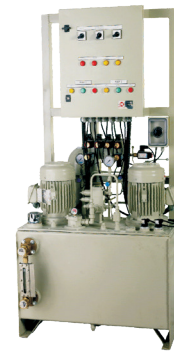
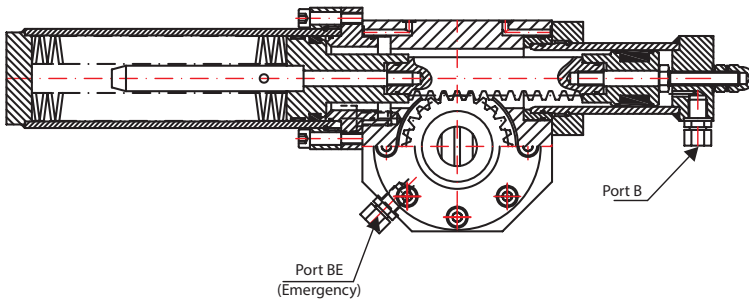

Hydraulic Power Pack

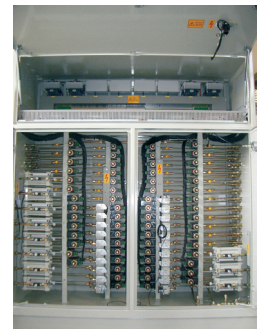

Solenoid Valve Box

Dimensions (mm)

Model	K	L	M	N	O	F	Max. G			Torque Output
							PS	DS	FH	
A300PT0035	166	110	60	46	96	F05-F07	14	14	14	35 Nm
A300PT0090	230	148	80	47	115	F05-F07	17	17	17	90 Nm
A300PT0165	320	210	100	60	155	F07-F10	24	24	22	165 Nm
A300PT0280	425	205	105	60	155	F10-F12	24	24	22	280 Nm
A300PT0370	425	215	110	60	155	F12-F14	30	30	27	370 Nm
A300PT0870	640	265	135	90	180	F14-F16	40	40	40	870 Nm